

Product Parts Breakdown

▲ Specify Finish

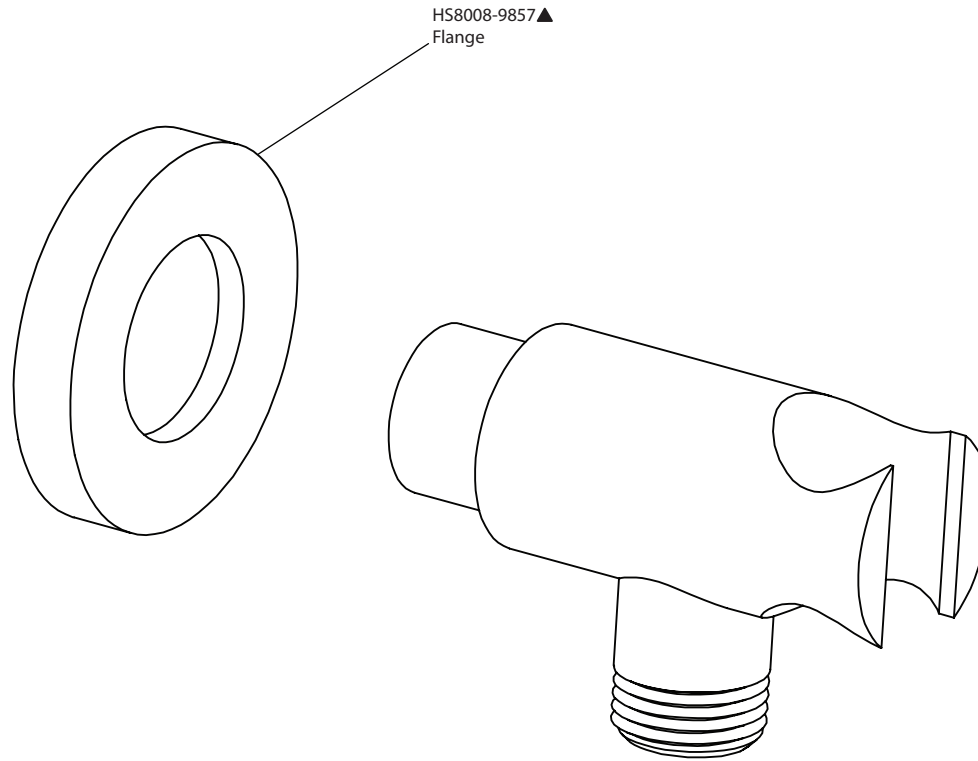

isenberg
innovation+design

HS8008

Ver 2.53